

HDi Multi-touch Screen Quick Start Guide - HDi Edge Series Android 8.0

The instructions below have been created to help you get started with your new HDi multi-touch screen. This document assumes a basic knowledge of computers and hardware. If you require more detail, please don't hesitate to contact us at info@hdinteractive.com.au.

Multi-touch Screen and Laptop set-up

1. Cables

Supplied with your multi-touch screen are various 2 metre cables.

USB A to B cable

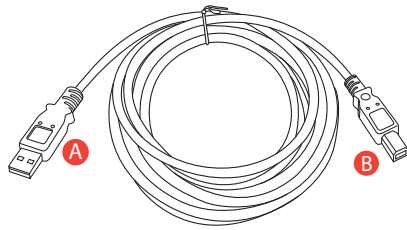

HDMI cable

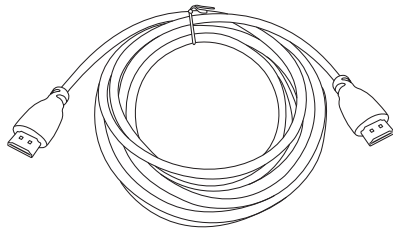

2. Rear panel

HDMI OUTPUT (Connect additional monitor)

HDMI (HDMI 1 Input Source)

TOUCH USB (Interactivity)

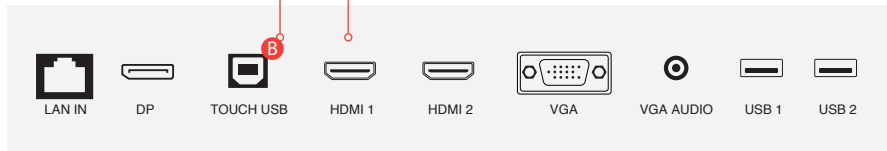
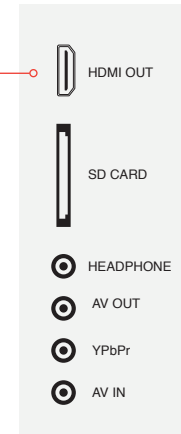

3. Front panel

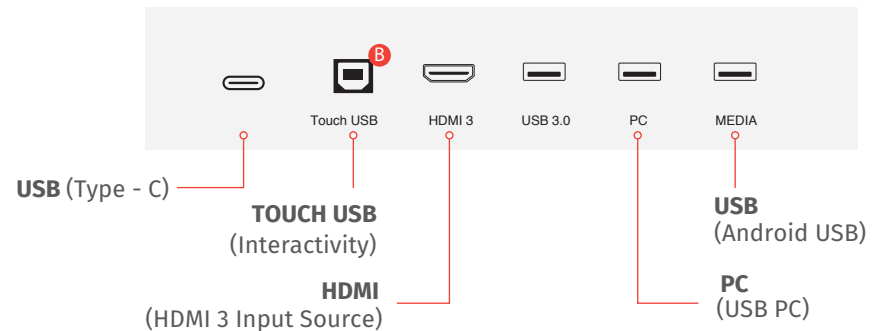

HDi Multi-touch Screen Quick Start Guide - HDi Edge Series Android 8.0

4. Connecting your Multi-touch-Screen and laptop

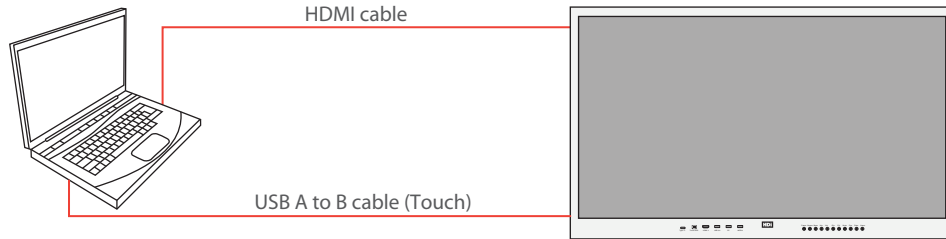

- Now that you are familiar with the cables, connect the B end of the USB A to B to the front / rear panel socket TOUCH USB. Then connect the A end to your laptop.
- If you are using HDMI, connect the cable to the front / rear panel HDMI socket and to your laptop.

5. Ready to use

You have now connected your multi-touch screen and laptop. Turn on your laptop and multi-touch screen. The multi-touch screen is now ready to use.

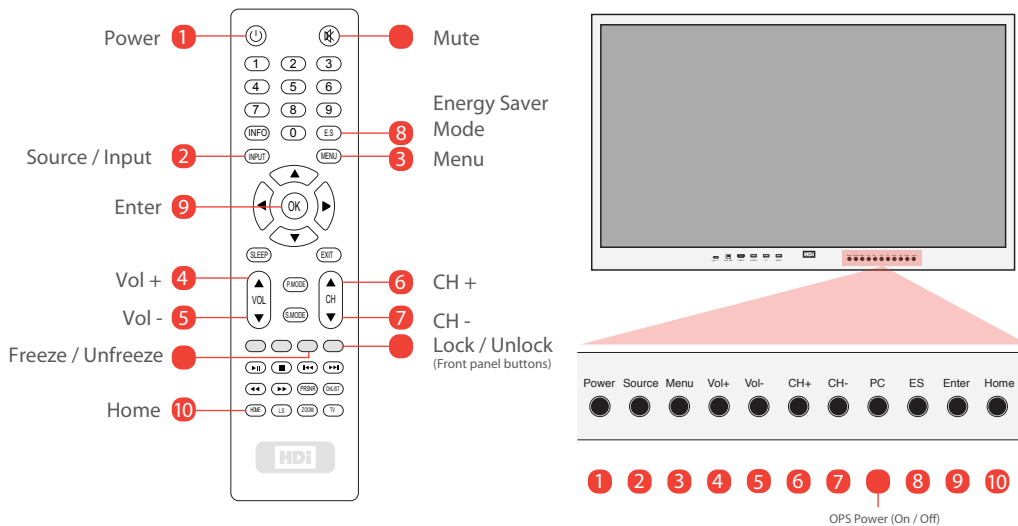

6. OSD

- 1 Click to open the left side bar
- 2 Annotation software
- 3 Go to all Android Apps
- 4 On screen user manual
- 5 Click to close the side bar
- 6 Click back home
- 7 Click to annotate
- 8 Quick access to OPS
- 9 Click to OSD menu
- 10 Click to change source
- 11 Click to reveal all open apps
- 12 Click to go back



7. Touch Functions

Tap to select

